

342



REPLACEABLE
TRANSPARENT
COVER

PROTECTED SWITCH

SOFT TOUCH HANDLE



LUX: 1500 @ 50 cm
LUMEN: 160
LIGHTING
ANGLE: 15°
342 LAMP

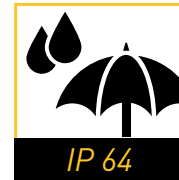
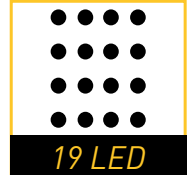

EN 60598-1 EN 60598-2-8
EN 60335-1
CE 
2014/35/UE 2014/30/UE
2011/65/UE

NEW MODEL ///

EN TECHNICAL FEATURES

- Luminous source 19 LED
- Electronic control of the charge: the lamp can be kept always on the battery charger

Pilot light on the lamp:

- **fixed red:** battery flat.
 - **flashing red:** lamp in recharge.
 - **fixed green:** the charge is completed.
- Charge maintenance function.

Caution: when the battery is almost down, the pilot led on the lamp is red. When the switch doesn't stay inserted anymore, the battery is flat. Recharge the lamp.

FR CARACTERISTIQUES TECHNIQUES

- Source de lumière: 19 LED
- Contrôle électronique de la charge: la lampe peut être toujours laissée sur le chargeur

Voyant lumineux sur la lampe:

- **rouge fixe:** batterie vide
 - **rouge clignotant:** lampe en recharge
 - **vert fixe:** recharge terminée.
- Fonction maintien de charge

Attention: quand la batterie est presque à plat, le voyant sur la lampe est rouge. Lorsque l'interrupteur ne reste plus enclenché, cela signifie que la batterie est à plat. Recharger la lampe.

DE TECHNISCHE MERKMALE

- Lichtquelle: 19 LED
- Elektronische Kontrolle der Aufladung: die Lampe kann immer im Ladegerät bleiben

Kontrollleuchte auf der Lampe:

- **rote Dauerleuchte:** leerer Akku
 - **rote Blinkleuchte:** die Lampe ist in Wiederaufladung
 - **grüne Dauerleuchte:** Laden fertiggestellt.
- Ladeerhaltungsfunktion.

ACHTUNG: Wenn die Batterie fast leer ist, leuchtet das rote Kontrollled in der Lampe auf. Wenn der Schalter nicht mehr eingeschaltet ist, bedeutet es, dass die Batterie vollständig leer ist. Die Lampe wieder laden.



ES CARACTERISTICAS TECNICAS

- Fuente del luz: 19 LED
- Control electrónico de la carga: la lámpara puede dejarse siempre en el cargador

Indicador luminoso sobre el cargador:

- **rojo fijo:** batería vacía
 - **rojo parpadeante:** lámpara en recarga
 - **verde fijo:** carga ultimada.
- Función mantenimiento de carga

ATENCIÓN: cuando la batería está casi descargada, se encenderá el indicador rojo en la lámpara. Cuando el interruptor no funciona al pulsarlo, significa que la batería está completamente descargada. Recargue la lámpara.

ART.	342
Description	Rechargeable LED lamp with charger
Light source	19 LED 5mm Ultra White
Battery	3,7 V - 2200 mAh - Li-PO
Battery charger	100/240 V (50/60 Hz)
	130
	360x120x95 mm - 1,1 Kg

ART. 342/9

Displayer with 9 lamps art. 342
 Présentoir avec 9 lampes réf. 342
 Ständer mit 9 Lampen Art. Nr. 342
 Expositor con 9 lamparas art. 342

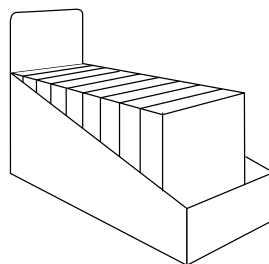

Dimensions

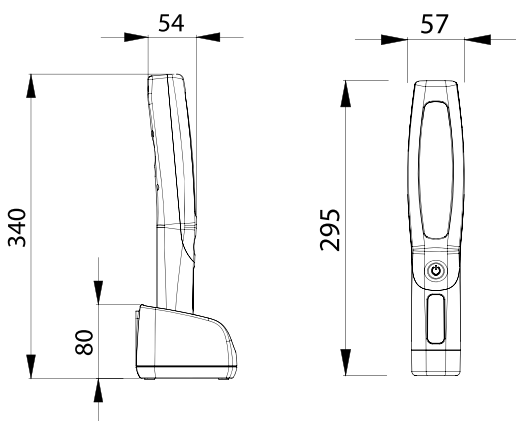

Spare Parts

ART. 345/VB

Transparent cover / Calotte transparente /
 Durchsichtige Abdeckplatte / Casquete transparente.

ART. 342/L

Lamp / Lampe / Lampe / Lámpara

ART. 342/C

Battery charger / Chargeur / Ladegerät / Cargador