

















Description	Balancer	Balancer	Balancer	Balancer with anti-fall device	Balancer with anti-fall device	Balancer with anti-fall device	Balancer with anti-fall device	Balancer with anti-fall device
ART.	620	621	622	623	624	625	626	627
NEW Textile cable in polyethylenic fibre HT								
ART.	630	631	632	633	634	635	636	637
Stainless steel support cable								
capacity Kg force Kg Tragleistung Kg	0,4 ÷ 1	1 ÷ 2	2 ÷ 3	2 ÷ 4	4 ÷ 6	6 ÷ 8	8 ÷ 10	10 ÷ 14
travel mm course du cable mm Kabelhublänge mm	1600	1600	1600	2500	2500	2500	2500	2500
weight gr poids gr Gewicht gr	630	670	790	2850	3000	3100	3200	3500
	mm 170x125x70 Kg 0,7	mm 170x125x70 Kg 0,8	mm 170x125x70 Kg 0,9	mm 245x200x110 Kg 3,2	mm 245x200x110 Kg 3,3	mm 245x200x110 Kg 3,4	mm 245x200x110 Kg 3,5	mm 245x200x110 Kg 3,6

Dimensions



Capacity adjustment

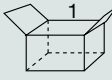
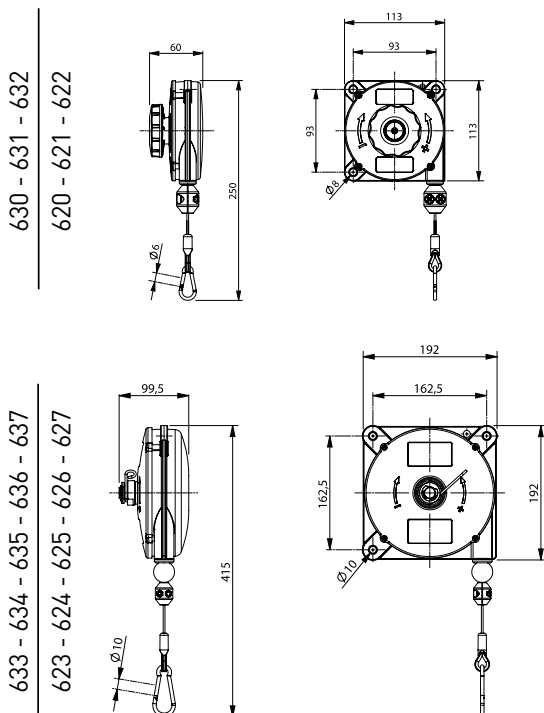